



Azienda
Company

Valori aziendali
Company Values

Qualità
Quality

Filosofia
Philosophy

Produzione
Production

Tubolari
Tubes

Tubi saldati tondi
Round Welded Tubes

Oval Welded Tubes

Tubi saldati ovali

Tubi saldati rettangolari
Rectangular Welded Tubes

Round Welded Tubes

Tubi saldati quadrati
Square Welded Tubes

Tubi saldati semiovali
Semi-Oval Welded Tubes

EUROFLEX S.p.A.
SIDERURGIA FLESSIBILE

Open Profiles

Profilati

"C" Profiles

Profilo a C

"Ω" Profiles

Profilo omega

"Z" Profiles

Profilo a Z

Profilo a U
"U" Profiles

Profilo a L

"L" Profiles

Elementi zincati
Galvanized Elements

Nastri
Strips

Lamiere
Plates





Azienda

Euroflex S.p.A. è una società specializzata nella lavorazione di prodotti siderurgici. L'azienda si colloca con successo tra i leader nazionali del settore.

Fondata nel 1967, Euroflex S.p.A. è posizionata in maniera strategica vicino ai maggiori raccordi autostradali e al porto di Salerno.

L'impegno profuso in tanti anni di attività, unito a una forte politica orientata allo sviluppo, ha messo l'azienda in condizione di offrire soluzioni flessibili nella produzione di tubolari, profilati aperti, nastri, lamiere piane e grecate per i più ampi utilizzi.

Euroflex S.p.A. specializes in manufacturing of steel products.

The company is one of the most successful among the national leaders of the field.

Founded in 1967, it was collocated in a strategic position, near to the most important motorway junctions and Salerno port.

Our constant commitment over several years of activity, together with a development-oriented policy, allowed the company to offer a range of versatile solutions in the production of tubes, open profiles, strips, plane and corrugated plates for several uses.

Company





Filosofia

Il nostro approccio si basa sul concetto della siderurgia flessibile: creiamo le condizioni ottimali per produrre ciò che risponde alle reali esigenze del cliente, con produzioni dedicate e con un'attenzione particolare alla qualità dei prodotti finiti.



Our approach is based on the concept of versatile steel industry: we create the best conditions to produce what the customer really needs, with specific productions and paying particular attention to the quality of our products.

Philosophy





Valori aziendali

Flessibilità

Non pieghiamo semplicemente l'acciaio, ma lo rendiamo adatto alle esigenze dei nostri clienti.

Eccellenza

Un prodotto di qualità non può prescindere dalle norme vigenti. Ogni nostra certificazione testimonia l'impegno per garantire il massimo in termini di efficacia ed efficienza.

Sviluppo

Guardiamo sempre avanti per migliorare i nostri obiettivi e raggiungere nuovi traguardi.

Sicurezza

Creare le giuste condizioni di lavoro è la nostra priorità.

Flexibility

We don't simply fold the steel, we make it suitable to our customers needs.

Excellence

A quality product can't prescind from the rules in force and each certification we have, shows our involvement in guaranteeing the highest effectiveness and efficiency.

Development

We constantly look to improvement and to reach new goals.

Security

Our priority is to create the right work conditions.

Company Values



Qualità

L'assoluta qualità dei nostri prodotti è garantita dalla scelta di fornitori qualificati all'origine, dall'utilizzo di materie prime di elevata qualità e dall'adozione di standard di produzione sempre più alti. Le certificazioni ottenute testimoniano la nostra politica orientata al miglioramento continuo.

Certificazioni

UNI EN ISO 9001:2008
UNI EN ISO 14001:2004
UNI EN ISO 10219-1:2006 **CE**

Attestato di denuncia dell'attività di centro di trasformazione

N. 1860/11 e 2062/12 per Centro di produzione di lamiere grecate e profilati formati a freddo.

The excellent quality of our products is guaranteed by several elements, as qualified suppliers, the employment of excellent raw material and higher and higher production standards. The certifications obtained across the years are a mark of our policy oriented to a continuous improvement.

Certificates

UNI EN ISO 9001:2008
UNI EN ISO 14001:2004
UNI EN ISO 10219-1:2006 **CE**

Processing Centre Activity Reporting Certificate N. 1860/11 for Centre of Production of Corrugated plates for cold forming profiles.

NORME DI RIFERIMENTO / REFERENCE RULES

		MATERIALI PRODOTTI / PRODUCTS		
		Tubolari Tubes	Profilati aperti Hollow Sections	Nastri e Lamiere Strips and Sheets
QUALITÀ / QUALITY	CALDO HOT			
	S185 S235 S275 S355 S430	EN 10025 EN 10219	EN 10025 EN 10162	EN 10025 EN 10029
	ZINCATO GALVANISED			
	DX51D+Z S250 S280 S350GD+Z	EN 10143 EN 10219	EN 10346 EN 10162	EN 10143 EN 10346
	FREDDO COLD			
	DC01	EN 10130 EN 10219	EN 10130 EN 10162	EN 10130 EN 10131
	DECAPATO PICKLED			
	DD11	EN 10111 EN 10219	EN 10111 EN 10162	EN 10111

Quality



Produzione

La dimensione produttiva degli impianti permette ad Euroflex S.p.A. di offrire una vasta gamma di prodotti, grazie a linee di produzione dedicate per i vari tipi di taglio e di formazione del profilo.

Ogni prodotto è utilizzabile in diversi settori.

Il nostro concetto di siderurgia flessibile, inoltre, ci permette di rispondere con efficacia a particolari richieste, anche al di là dei normali standard produttivi. Profili speciali possono essere pensati e realizzati dal nostro ufficio tecnico, secondo le esigenze del cliente.

The current productive dimensions of the machines allow Euroflex S.p.A. to offer a wide selection of products thanks to specific production lines for several kinds of cuts or formation of profiles; every product can be used in several sectors.

Our concept of versatile iron and steel industry makes us able to satisfy the most various requests, beyond the productive standards. Special profiles can be thought and realized by our technical department according to customer requests.



Production











SCHEDA COMPARATIVA DEI PRODOTTI

CAMPI DI APPLICAZIONE	 EDILIZIA	 CARPENTERIA	 SEGNALETICA STRADALE	 SERRE PER AGRIGOLTURA	 MOBILIO	 FOTOVOLTAICO	 SCAFFALATURE	 GRIGLIATO ELETTROFUSO
PRODOTTI								

Tubolari	✓	✓	✓	✓	✓	✓	✓	✓
Profilati	✓	✓		✓		✓	✓	✓
Nastri	✓	✓	✓	✓	✓		✓	✓
Lamiere	✓	✓		✓			✓	

PRODUCTS COMPARATIVE FILE

FIELDS OF APPLICATION	 BUILDING CONSTRUCTION	 GENERAL CARPENTRY	 ROADSIGNS	 GREENHOUSES	 FURNITURE TUBES	 PHOTOVOLTAIC	 SCAFFOLDING	 ELECTRO-FUSED STEEL GRATING PANEL
PRODUCTS								

Tubes	✓	✓	✓	✓	✓	✓	✓	✓
Open Profiles	✓	✓		✓		✓	✓	✓
Strips	✓	✓	✓	✓	✓		✓	✓
Plates	✓	✓		✓			✓	

Tubolari

Fornitura standard

Barre di lunghezza commerciale di 6.000 mm.

Fornitura flessibile

Barre da 3.000 mm a 12.000 mm oppure tagliate su misura fino a una lunghezza minima di 50 mm.

Elenco prodotti

Tubi saldati tondi, rettangolari, quadri, ovali e semiovali.

Campi di applicazione

Ponteggi per edilizia
Carpenteria
Segnaletica stradale
Serre per agricoltura
Mobilio
Fotovoltaico
Scaffalature
Grigliato elettrofuso

Standard Supply

Standard size supply with bars of commercial length 6 mt.

Versatile Supply

Versatile Supply, bars from 3 mt till 12 mt or cut on request till 50 mm length.

List of products

Round, rectangular, square, oval and semi-oval welded tubes.

Fields of application

Scaffolding For Building Construction, General Carpentry, Roadsigns, Greenhouses, Furniture Tubes, Photovoltaic, Scaffolding, Electro-Fused Steel Grating Panel

Tubes



TUBI SALDATI TONDI

ROUND WELDED TUBES

peso in kg per metro lineare / kg weight per linear meter

Ø DIAMETRI / DIAMETER (mm)	SPESSORI / THICKNESS (mm)										
	0,8	1,0	1,2	1,5	1,8	2,0	2,3	2,5	2,7	3,0	4,0
16	0,33	0,40	0,48	0,60							
18	0,37	0,46	0,55	0,68	0,81	0,89					
20	0,40	0,49	0,59	0,73	0,88	0,97					
21	0,43	0,53	0,64	0,79	0,93	1,04	1,19				
22	0,44	0,55	0,65	0,81	0,97	1,07	1,21				
25	0,51	0,63	0,75	0,94	1,12	1,24	1,41				
26,75	0,53	0,67	0,80	0,98	1,17	1,30	1,50	1,63	1,74	1,91	
28,7	0,57	0,72	0,86	1,07	1,28	1,41	1,59	1,73	1,85		
30	0,60	0,75	0,88	1,11	1,32	1,46	1,68				
32	0,65	0,80	0,96	1,19	1,43	1,58	1,82	1,94	2,10	2,28	
33	0,67	0,83	0,99	1,25	1,47	1,63	1,88	2,03	2,18	2,42	
33,8	0,68	0,85	1,02	1,26	1,50	1,66	1,89	2,05	2,19	2,43	
35	0,71	0,87	1,05	1,31	1,55	1,73	1,96	2,13	2,28		
38	0,77	0,96	1,15	1,44	1,71	1,90	2,17	2,34	2,53	2,75	3,64
40	0,80	0,99	1,20	1,48	1,78	1,98	2,26	2,43	2,61	2,90	3,83
42,5	0,83	1,04	1,24	1,54	1,84	2,04	2,35	2,53	2,73	3,04	4,02
45		1,10	1,33	1,64	1,96	2,18	2,49	2,71	2,90	3,23	4,27
48		1,18	1,41	1,75	2,10	2,32	2,67	2,90	3,12	3,46	4,64
48,4 ^{sc}				1,79	2,16	2,36	2,74	2,93	3,02	3,55	
50		1,24	1,47	1,83	2,19	2,48	2,84	3,08	3,31	3,67	4,86
51		1,24	1,51	1,87	2,23	2,48	2,84	3,08	3,31	3,67	
54			1,99	2,39	2,64	3,04	3,29	3,55	3,90	4,00	5,30
55				2,02	2,42	2,68					
56				2,06	2,46	2,73					
57				2,09	2,51	2,79	3,14	3,45		4,12	
60			1,76	2,20	2,63	2,92	3,35	3,65	3,94	4,36	5,77
60 ^{sc}					2,69	2,99	3,44	3,74	4,00		
63				2,33	2,78	3,09		3,85	4,15	4,59	6,09
70				2,58	3,08	3,41		4,26		5,11	
76			2,27	2,84	3,36	3,72		4,63	5,53	7,35	
89					3,93	4,35	5,02	5,44	6,52	8,67	8,66
95					4,20	4,65	5,34	5,81	6,26	6,95	9,26
102					4,51	4,99	5,74	6,24	6,74	7,46	9,92



**TUBI
SALDATI
TONDI**

*ROUND
WELDED
TUBE*

NORME DI RIFERIMENTO

REFERENCE RULES

		NORMATIVE / RULES
QUALITÀ / MATERIALS	CALDO HOT ROLLED STEEL COILS	
	S185 S235JR/JR+M S275 S355 S430	EN 10025 EN 10219
	ZINCATO GALVANISED STEEL COILS	
	DX51D+Z S250 S280 S350GD+Z	EN 10143 EN 10219
	FREDDO COLD ROLLED STEEL COILS	
	DC01	EN 10130 EN 10219
	DECAPATO PICKLED STEEL COILS	
	DD11	EN 10111 EN 10219

TUBI SALDATI RETTANGOLARI

RECTANGULAR WELDED TUBES

peso in kg per metro lineare / kg weight per linear meter

		SPESSORI / THICKNESS (mm)									
		1,0	1,2	1,5	1,8	2,0	2,3	2,5	2,7	3,0	4,0
Ø SEZIONI / SECTION (mm)	20x10	0,47	0,56	0,7							
	25x15	0,63	0,75	0,94		1,24					
	25x20	0,72	0,86	1,07		1,41					
	30x10	0,63	0,75	0,94		1,24					
	30x15	0,72	0,86	1,07		1,41					
	30x20	0,80	0,96	1,19		1,58		1,94		2,28	
	30x25	0,87	1,05	1,31		1,73					
	35x10	0,72	0,86	1,07		1,41					
	35x15	0,80	0,96	1,19		1,58					
	35x20	0,87	1,05	1,31		1,73					
	35x25	0,96	1,15	1,44		1,90					
	35x30	1,04	1,24	1,54		2,04		2,53		3,04	
	40x10	0,80	0,96	1,19		1,58					
	40x15	0,87	1,05	1,31		1,73					
	40x20	0,96	1,15	1,44		1,90		2,34		2,75	
	40x25	1,04	1,24	1,54		2,04		2,53		3,04	
	40x30		1,33	1,64		2,18		2,71		3,23	
	40x35		1,41	1,75		2,32		2,90		3,46	
	45x10	0,87	1,05	1,31		1,73					
	45x15	0,96	1,15	1,44		1,90					
	50x10	0,96	1,15	1,44		1,90					
	50x15	1,04	1,24	1,54		2,04					
	50x20		1,33	1,64		2,18		2,71		3,23	
	50x25		1,41	1,75		2,32		2,90		3,46	
	50x30		1,51	1,87		2,48		3,08		3,67	
	50x40			2,09		2,79		3,45		4,12	
	60x10		1,33	1,64		2,18					
	60x15		1,41	1,75		2,32					
	60x20		1,51	1,87		2,48		3,08		3,67	
	60x25	1,33	1,59	1,98		2,39	2,64	3,04	3,29	3,55	3,9
	60x30			2,09		2,79		3,45		4,12	
	60x35			2,20		2,92		3,65		4,36	
	60x40			2,33		3,09		3,85		4,59	
	60x50			2,58		3,41		4,26		5,11	
	70x20			2,09		2,79		3,45		4,12	
	70x25			2,20		2,92		3,65		4,36	
	70x30			2,33		3,09		3,85		4,59	
	70x40			2,58		3,41		4,26		5,11	
	70x50			2,84		3,72		4,63		5,53	7,35
	80x20		1,87	2,33		3,09		3,85		4,59	
80x30			2,58		3,41		4,26		5,11		
80x40			2,84		3,72		4,63		5,53	7,35	
80x60					4,35		5,44		6,52	8,67	
90x30			2,84		3,72		4,63		5,53	7,35	
90x50					4,35		5,44		6,52	8,67	
90x60					4,65		5,81		6,95	9,26	
100x20			2,84		3,72		4,63		5,53	7,35	
100x30					4,03		5,02		6	7,94	
100x40					4,35		5,44		6,52	8,67	
100x50					4,65		5,81		6,95	9,26	
100x60					4,99		6,24		7,46	9,92	
120x30					4,65		5,81		6,95	9,26	
120x40					4,99		6,24		7,46	9,92	



**TUBI
SALDATI
RETTANGOLARI**

*RECTANGULAR
WELDED
TUBES*

NORME DI RIFERIMENTO

REFERENCE RULES

		NORMATIVE / RULES
QUALITÀ / MATERIALS	CALDO HOT ROLLED STEEL COILS	
	S185 S235JR/JR+M S275 S355 S430	EN 10025 EN 10219
	ZINCATO GALVANISED STEEL COILS	
	DX51D+Z S250 S280 S350GD+Z	EN 10143 EN 10219
	FREDDO COLD ROLLED STEEL COILS	
	DC01	EN 10130 EN 10219
	DECAPATO PICKLED STEEL COILS	
	DD11	EN 10111 EN 10219

TUBI SALDATI QUADRI

SQUARE WELDED TUBES

peso in kg per metro lineare / kg weight per linear meter

		SPESSORI / THICKNESS (mm)									
		1,0	1,2	1,5	1,8	2,0	2,3	2,5	2,7	3,0	4,0
Ø SEZIONI / SECTION (mm)	15x15	0,47	0,56	0,70							
	20x20	0,63	0,75	0,94	1,12	1,24					
	25x25	0,80	0,96	1,19	1,43	1,58		1,94		2,28	
	30x30	0,96	1,15	1,44	1,71	1,90	2,13	2,34	2,49	2,75	
	35x35			1,64		2,18		2,71		3,23	
	40x40	1,26	1,52	1,87	2,23	2,48		3,08		3,67	
	50x50			2,33		3,09		3,85		4,59	
	60x60			2,84		3,72		4,63		5,53	7,35
	70x70					4,35		5,44		6,52	8,67
	80x80					4,99		6,24		7,46	9,92



TUBI SALDATI QUADRI

SQUARE WELDED TUBES

TUBOLARI A SEZIONE SEMIOVALE

SEMI-OVAL SECTION TUBES

peso in kg per metro lineare / kg weight per linear meter

		SPESSORI / THICKNESS (mm)									
		1,0	1,2	1,5	1,8	2,0	2,5				
Ø SEZIONI / SECTION (mm)	36x16						1,73				
	50x25	1,11	1,31	1,63							
	40x25	0,95	1,13	1,40							



TUBI SALDATI SEMIOVALI

SEMI-OVAL SECTION TUBES

TUBOLARI A SEZIONE OVALE

OVAL SECTION TUBES

peso in kg per metro lineare / kg weight per linear meter

		SPESSORI / THICKNESS (mm)									
		1,0	1,2	1,5	1,8	2,0					
Ø SEZIONI / SECTION (mm)	30x15	0,63	0,73	0,94	1,12	1,24					
	50x10	0,87	1,05	1,31							



TUBI SALDATI OVALI

OVAL SECTION TUBES

NORME DI RIFERIMENTO

REFERENCE RULES

		NORMATIVE / RULES
QUALITÀ / MATERIALS	CALDO HOT ROLLED STEEL COILS	
	S185 S235JR/JR+M S275 S355 S430	EN 10025 EN 10219
	ZINCATO GALVANISED STEEL COILS	
	DX51D+Z S250 S280 S350GD+Z	EN 10143 EN 10219
	FREDDO COLD ROLLED STEEL COILS	
	DC01	EN 10130 EN 10219
	DECAPATO PICKLED STEEL COILS	
	DD11	EN 10111 EN 10219



 **EUROFLEX** S.p.A.
SIDERURGIA FLESSIBILE

Profilati

Fornitura standard

Barre dalla lunghezza commerciale di 6.000 mm.

Fornitura flessibile

È possibile fornire il prodotto in dimensioni diverse, in base alle misure richieste. Possiamo, inoltre, forare ed asolare i profili.

Elenco prodotti

Profilati aperti ad U a lati uguali e disuguali, profilati aperti angolari, profilati aperti a C, profilati aperti Omega, profilati aperti a L, profilati aperti a Z.

Campi di applicazione

Edilizia
Carpenteria
Serre per agricoltura
Fotovoltaico
Scaffalature
Grigliato elettrofuso

Standard Supply

Standard size supply with bars of commercial length 6 mt.

Versatile Supply

It's possible to supply the product in several sizes, upon requests. It is also possible to drill and slot the profiles.

List of products

"U" Open Profiles Equal and Unequal Sides, Angular Open Profiles, "C" Open Profiles, "Ω" Open Profiles, "L" Open Profiles, "Z" Open Profiles.

Fields of application

Building Construction, General Carpentry, Greenhouses, Photovoltaic, Scaffolding, Electro-Fused Steel Grating Panel

Open Profiles



PROFILO AD "U"
"U" OPEN PROFILE

ALTEZZA HEIGHT (H)		BASE BASE (B)		SPESSORE THICKNESS (T)	
MIN	MAX	MIN	MAX	MIN	MAX
6 mm	140 mm	8 mm	300 mm	0.6 mm	4 mm

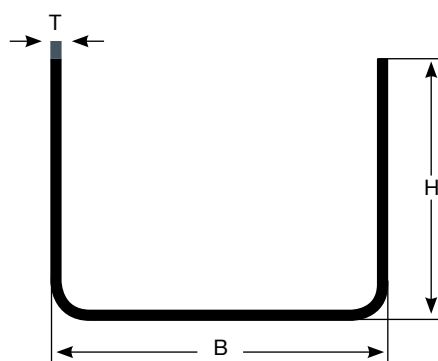

**PROFILO
AD "U"**

"U"
OPEN
PROFILE

Modalità di applicazione fori ed asole
Way of application holes and eyelets

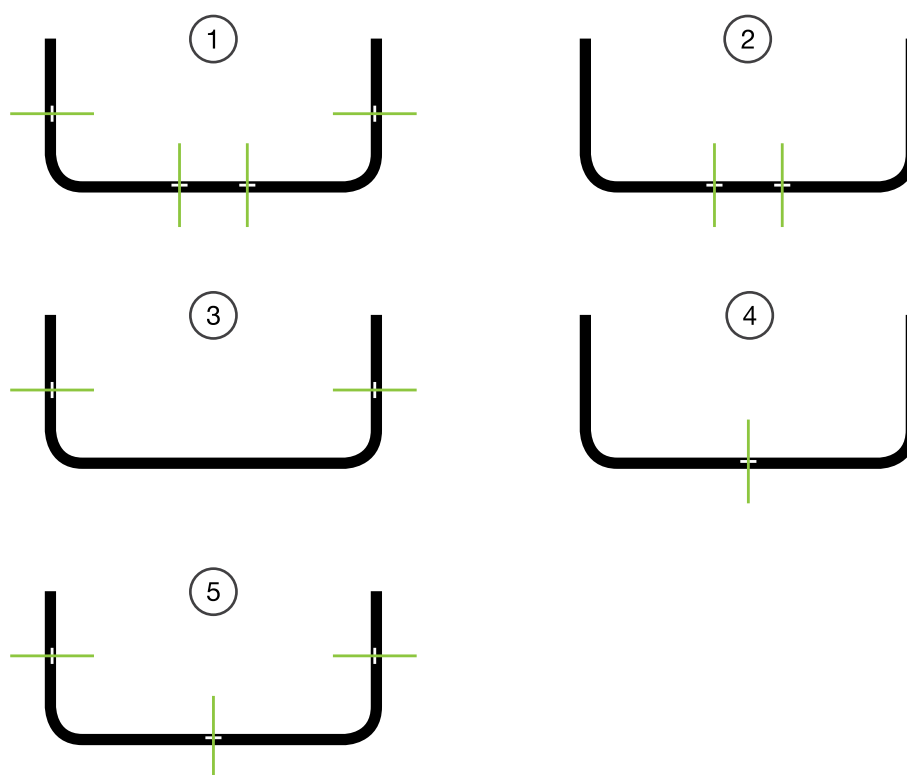

NORME DI RIFERIMENTO

REFERENCE RULES

		NORMATIVE / RULES
QUALITÀ / MATERIALS	CALDO HOT ROLLED STEEL COILS	
	S185 S235JR/JR+M S275 S355 S430	EN 10025 EN 10162
	ZINCATO GALVANISED STEEL COILS	
	DX51D+Z S250 S280 S350GD+Z	EN 10346 EN 10162
	FREDDO COLD ROLLED STEEL COILS	
	DC01	EN 10130 EN 10162
	DECAPATO PICKLED STEEL COILS	
	DD11	EN 10111 EN 10162

PROFILO A "C"
"C" OPEN PROFILE

ALTEZZA HEIGHT (H)		BASE BASE (B)		ALETTE TABS (C)		SPESSORE THICKNESS (T)	
MIN	MAX	MIN	MAX	MIN	MAX	MIN	MAX
15 mm	140 mm	25 mm	300 mm	6 mm	30 mm	0.8 mm	4 mm

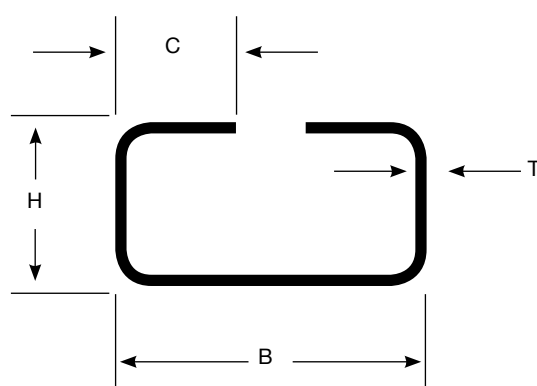

**PROFILO
A "C"**

"C"
OPEN
PROFILE

Modalità di applicazione fori ed asole
Way of application holes and eyelets

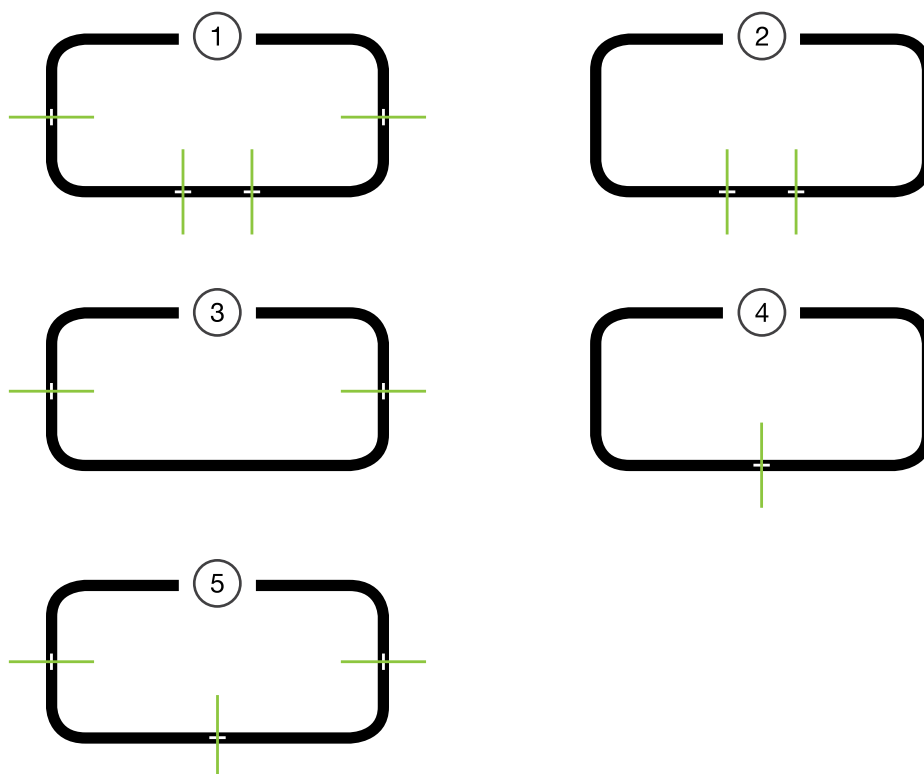



NORME DI RIFERIMENTO

REFERENCE RULES

		NORMATIVE / RULES
QUALITÀ / MATERIALS	CALDO HOT ROLLED STEEL COILS	
	S185 S235JR/JR+M S275 S355 S430	EN 10025 EN 10162
	ZINCATO GALVANISED STEEL COILS	
	DX51D+Z S250 S280 S350GD+Z	EN 10346 EN 10162
	FREDDO COLD ROLLED STEEL COILS	
	DC01	EN 10130 EN 10162
	DECAPATO PICKLED STEEL COILS	
	DD11	EN 10111 EN 10162

PROFILO OMEGA
"OMEGA" OPEN PROFILE

ALTEZZA HEIGHT (H)		BASE BASE (B)		ALETTE TABS (C)		SPESSORE THICKNESS (T)	
MIN	MAX	MIN	MAX	MIN	MAX	MIN	MAX
20 mm	160 mm	20 mm	250 mm	10 mm	40 mm	0.8 mm	4 mm

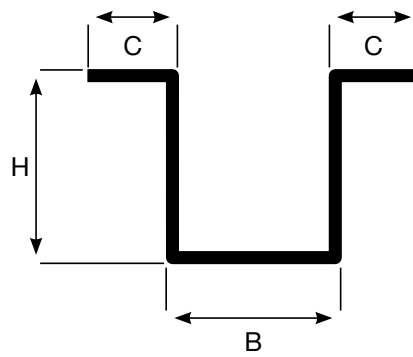

**PROFILO
OMEGA**

"Ω"
OPEN
PROFILE

Modalità di applicazione fori ed asole
Way of application holes and eyelets

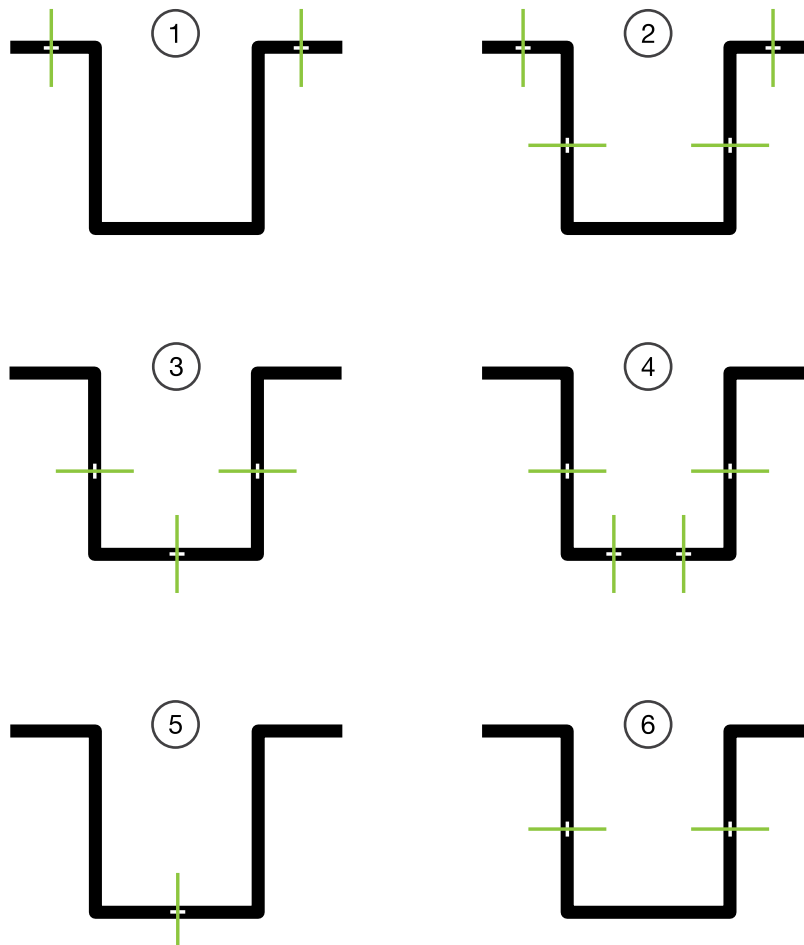

NORME DI RIFERIMENTO

REFERENCE RULES

		NORMATIVE / RULES
QUALITÀ / MATERIALS	CALDO HOT ROLLED STEEL COILS	
	S185 S235JR/JR+M S275 S355 S430	EN 10025 EN 10162
	ZINCATO GALVANISED STEEL COILS	
	DX51D+Z S250 S280 S350GD+Z	EN 10346 EN 10162
	FREDDO COLD ROLLED STEEL COILS	
	DC01	EN 10130 EN 10162
	DECAPATO PICKLED STEEL COILS	
	DD11	EN 10111 EN 10162

PROFILO ANGOLARE E PROFILO A "L"
"L" OPEN PROFILE AND ANGOLAR OPEN PROFILE

LATO SIDE (A)		SPESSORE THICKNESS (T)	
MIN	MAX	MIN	MAX
10 mm	80 mm	1 mm	4 mm

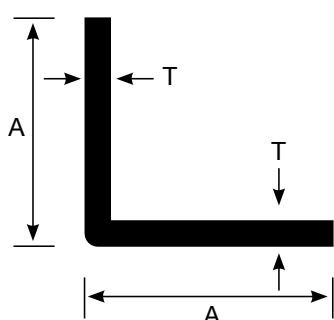

PROFILO A "L"

"L"
OPEN
PROFILE
AND ANGOLAR
OPEN
PROFILE

PROFILO A "Z"
"Z" OPEN PROFILE

ALTEZZA HEIGHT (A)	ALTEZZA HEIGHT (B)	ALTEZZA HEIGHT (C)	SPESSORE THICKNESS (T)
da 30 mm a 100 mm	da 20 mm a 40 mm	da 20 mm a 60 mm	da 1.2 mm a 3 mm

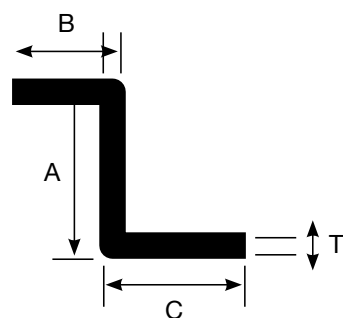

PROFILO A "Z"

"Z"
SECTION

ELEMENTI ZINCATI PER SERRANDE
GALVANISED ELEMENTS FOR SHUTTERS

Lisci, nervati e zigrinati da 0.6 mm a 1 mm

Terminali zincati da 1 mm a 1.2 mm

Possibilità di foratura delle doghe

Plane, ribbed, milled elements

Galvanised end elements

It is possible to drill the stave



ELEMENTI ZINCATI

GALVANISED
ELEMENTS
FOR SHUTTERS

NORME DI RIFERIMENTO

REFERENCE RULES

		NORMATIVE / RULES
QUALITÀ / MATERIALS	CALDO HOT ROLLED STEEL COILS	
	S185 S235JR/JR+M S275 S355 S430	EN 10025 EN 10162
	ZINCATO GALVANISED STEEL COILS	
	DX51D+Z S250 S280 S350GD+Z	EN 10346 EN 10162
	FREDDO COLD ROLLED STEEL COILS	
	DC01	EN 10130 EN 10162
	DECAPATO PICKLED STEEL COILS	
	DD11	EN 10111 EN 10162



 **EUROFLEX** S.p.A.
SIDERURGIA FLESSIBILE

Nastri

Non abbiamo limiti dimensionali di produzione. Possiamo tagliare i COILS, a misura, portandoli ad una larghezza tale da soddisfare le diverse esigenze del mercato.

Campi di applicazione

Edilizia
Carpenteria
Segnaletica stradale
Serre per agricoltura
Scaffalature
Grigliato elettrofuso
Frangisole

Our production has no dimensional limits. We can offer customized cuts, up to the requested width, so that to satisfy different market needs.

Fields of application

Building Construction,
General Carpentry,
Roadsigns,
Greenhouses,
Scaffolding,
Electro-fused Steel
Grating Panel,
Sun Screen Louvres

Strips



Lamiere

Lamiere piane, striate, bugnate

Larghezza commerciale
da 1.000 a 2.000 mm (su
richiesta larghezza intermedia)

Spessori

0.5 mm - 6 mm

Campi di applicazione

Edilizia
Carpenteria
Serre per agricoltura
Scaffalature

Lamiere grecate EGB 401

per coperture, pareti
e controsoffitti.

Spessori

da 0.5 mm a 0.8 mm

Qualità

Zincata e preverniciata
(testa di moro, rosso
siena, bianco grigio
ed altri colori su richiesta).

Plates

Plane, Corrugated,
Buckle

Width

commercial from 1000
to 2000 (upon request
intermediate width)

Thickness

0.5 mm - 6 mm

Fields of application

Building Construction,
General Carpentry,
Greenhouses,
Scaffolding.

Sheets

Egb 401 Corrugated
Plates For Cover, Wall,
False Ceiling

Thickness

from 0.5 mm to 0.8 mm

Quality

Galvanized
and pre-painted (dark
brown, Siena red, grey
white and other colors
upon request).

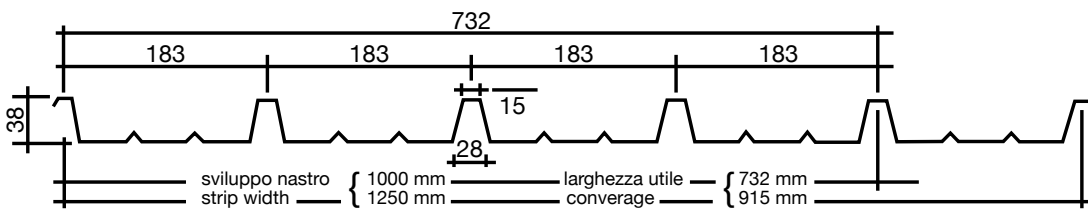

Plates

NORME DI RIFERIMENTO

REFERENCE RULES

		NORMATIVE / RULES
QUALITÀ / MATERIALS	CALDO HOT ROLLED STEEL COILS	
	S185 S235JR/JR+M S275 S355 S430	EN 10025 EN 10029
	ZINCATO GALVANISED STEEL COILS	
	DX51D+Z S250 S280 S350GD+Z	EN 10346 EN 10346
	FREDDO COLD ROLLED STEEL COILS	
	DC01	EN 10130 EN 10131
	DECAPATO PICKLED STEEL COILS	
	DD11	EN 10111



 **EUROFLEX** S.p.A.
SIDERURGIA FLESSIBILE

